

MOBIARM™

DATA SHEET / DATABLAD / DATENBLATT / FICHE TECHNIQUE

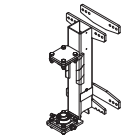

B: Wall bracket

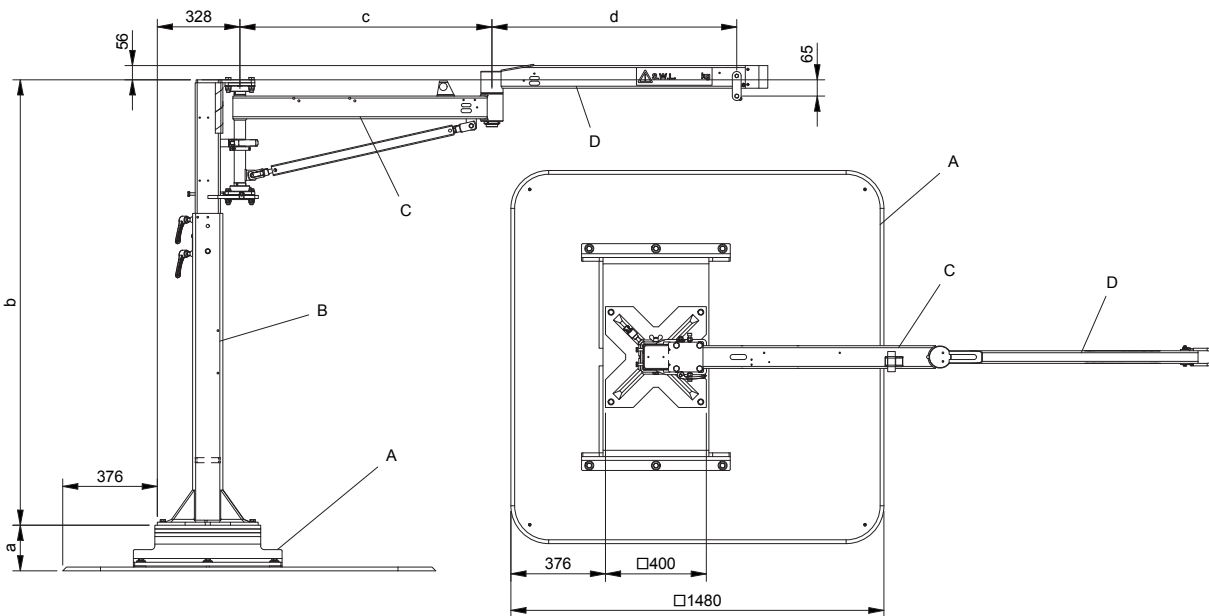
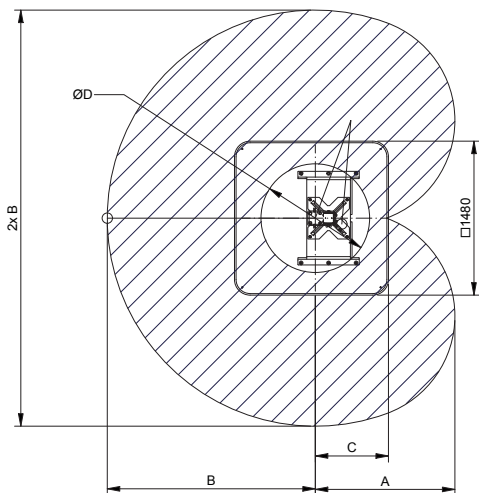

L1	L2	A	B	C	ØD
1000	1000	1345	1970		855
1000	1500	1845	2470		1410
1500	1500	1980	2970	703	780
1500	2000	2485	3470		1300
2000	2000	2720	3970		700

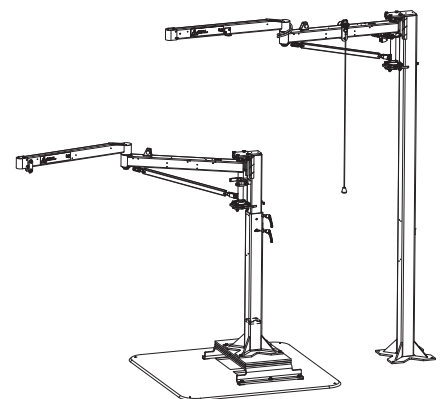

B / B+500

B Fix

TECHNICAL DATA

TEKNISKA DATA / TECHNISCHE DATEN / DONNÉES TECHNIQUES

Tare weight (excl. A)	Egenvikt / Eigengewicht / Poids propre	≤ 170 kg
Maximum load	Max. Last / Charge maximale	50-125 kg
Work temperature	Arbetstemp. / Betriebstemp. / Temp. de régime	5 - 40 °C

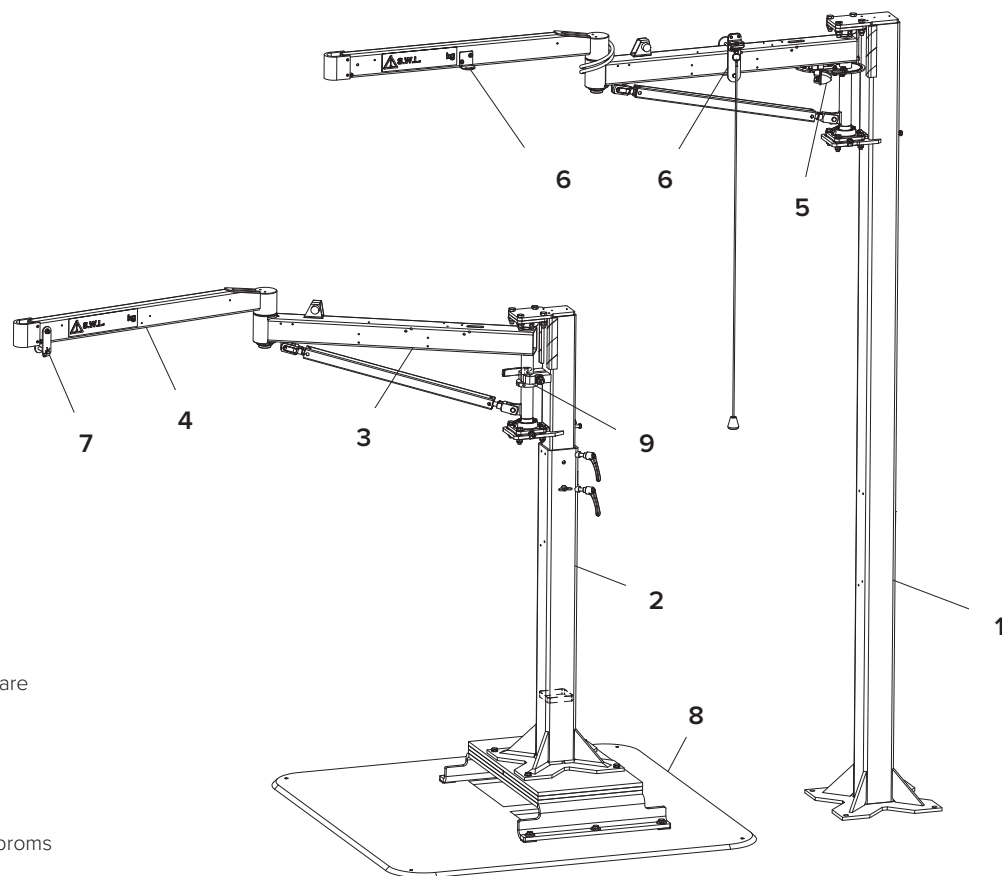

1. Fixed pillar (B Fix)
2. Adjustable pillar (B, B+500)
3. Inner arm
4. Outer arm
5. Rotation limiter / Rotationsbegränsare
6. Jib arm rotation lock / Armlås
7. Lift unit suspension / Lyftöra
8. Mobile platform / Fotplatta
9. Parking and drift brake / Rotationsbroms

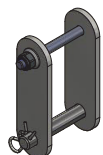

7. Lift unit suspension UNIVERSAL

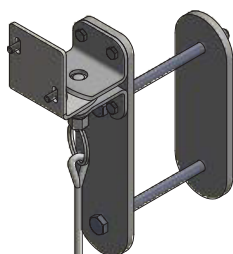

6. Jib arm rotation lock

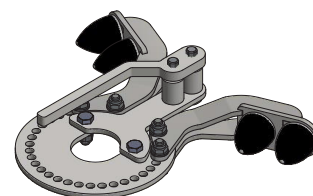

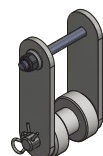

5. Rotation limiter

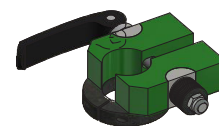

7. Lift unit suspension GMC



9. Parking and drift brake

								SWL (c + d) kg ¹ B (B +500, B Fix)				
	Dimensions [mm]	 	a	Bolts	b	c	d	2000	2500	3000	3500	4000
A	A0	272 kg	743509	136				100 (100)	52 (55)	17 (19)		
	A1	308 kg	743510	151				110 (112)	65 (69)	27 (30)	4 (6)	
	A2	344 kg	743429	166				121 (123)	80 (83)	38 (40)	13 (15)	
	A3	381 kg	743425	181				125 (125)	90 (90)	49 (51)	22 (23)	
	A4	418 kg	743250	196						60 (62)	30 (32)	8 (10)
	A5	455 kg	743251	211						70 (73)	39 (41)	15 (17)
	A6	491 kg	743252	226						80 (83)	48 (50)	23 (24)
	A7	528 kg	743418	241						85 (85)	57 (59)	30 (32)
	A8	564 kg	743428	256							65 (65)	38 (39)
	A9	600 kg	743535	271								45 (47)
A10	634 kg	743562	286								50 (50)	
B	B Fix	2+b×0,028 kg	743953		Bolts ³	≤ 3500 ²		125 ³	90 ³	85 ³	65 ³	50 ³
	B	83 kg	743253			1768 - 2728 ⁴						
	B +500	90 kg	743254			2268 - 3228 ⁴						
	B Wall	15 kg	743255									
C	C1		743256			1000						
	C1.5		743257			1500						
	C2		743258			2000						
D	D1		743259				1000					
	D1.5		743260				1500					
	D2		743261				2000					

Option	
Suspension ear / Upphängning	743928
Suspension ear / Upph. GMC	743929
Parking brake / Bremsa / Frein (inner)	743930
Rotation limiter / Rot.begränsare	743974
Jib arm lock	743931

Media supply / matning	
Pneu Ø12	743925
Pneu Ø12 x2	743927
Electric 230V	743924
Electric 230V + Pneu Ø12	743926

Bolts / shims	
Expander bolts M16x135	743573
Shims	743506

¹ c = d or/eller/oder/ou d = c+500

² Fixed height / Höje (max 3500 mm)

³ Installation in floor / golv / auf Boden / au sol

⁴ Adjustable height / justerbar höjd
 einstellbare Höhe / hauteur adjustable:
 position + 100 mm + 200 mm + ... etc.



Configuration / Konfiguration

() + + + + () + ()



Option

+ + + + +